

7FBEST10

Specifications					7FBEST10	
Identification	1.1	Manufacturer			Toyota	
	1.2	Model			7FBEST10	
	1.3	Drive			Electric	
	1.4	Operator type			Rider seated	
	1.5	Load capacity/rated load	Q		1000	
	1.6	Load centre	c		500	
	1.8	Load distance, centre of drive axle to fork	x		330	
	1.9	Wheelbase	y	mm	985	
	Weight	2.1	Service weight		kg	2550
2.2		Axle load, with load, front/rear		kg	2950/600	
2.3		Axle load, without load, front/rear		kg	1100/1450	
Tyres	3.1	Tyre - pneumatic (P), pneumatic shaped cushion (SE), solid rubber (R)			SE	
	3.2	Tyre size, front			18x7-8	
	3.3	Tyre size, rear			18x7-8	
	3.5	Wheels, number front/rear (x = driven wheels)			2/1x	
	3.6	Track width, front	b_{10}	mm	835	
	3.7	Track width, rear	b_{11}	mm	0	
	Dimensions	4.1	Tilt of mast/fork carriage forward/backward	α/β	deg	5/6
4.2		Height, mast lowered	h_1	mm	2140	
4.3		Free lift	h_2	mm	80	
4.4		Lift	h_3	mm	3270	
		Lift height	h_{23}	mm	3310	
4.5		Height, mast extended	h_4	mm	3815	
4.7		Height of overhead guard (cab)	h_6	mm	2055	
4.8		Seat height	h_7	mm	940	
4.12		Coupling height	h_{10}	mm	615	
4.19		Overall length	l_1	mm	2365	
4.20		Length to face of forks	l_2	mm	1565	
4.21		Overall width	b_1	mm	990	
4.22		Fork dimensions	s/e/l	mm	40/80/800	
4.23		Fork carriage DIN 15 173, class/type A, B			IIA	
4.24		Fork-carriage width	b_3	mm	900	
4.31		Ground clearance, with load, below mast	m_1	mm	55	
4.32		Ground clearance, centre of wheelbase	m_2	mm	80	
4.33		Aisle width for pallets 1000x1200 crossways	A_{st}	mm	2890	
4.34	Aisle width for pallets 800x1200 lengthways	A_{st}	mm	3020		
4.35	Turning radius	W_a	mm	1230		
4.36	Internal turning radius	b_{13}	mm	0		
Performance data	5.1	Travel speed, with/without load		km/h	12,0/12,5	
	5.2	Lift speed, with/without load		m/s	0,32/0,52	
	5.3	Lowering speed, with/without load		m/s	0,59/0,52	
	5.5	Drawbar pull, with/without load		N	1470/1670	
	5.6	Max. drawbar pull, with/without load		N	7300/7500	
	5.7	Gradeability, with/without load		%	8/12	
	5.8	Max. gradeability, with/without load		%	19/25	
	5.10	Service brake			Hydraulic	
	Electric motor	6.1	Drive motor rating S2 60 min		kW	5,1
		6.2	Lift motor rating S3 15%		kW	7,5
6.3		Battery according to DIN 43 531/35/36 A, B, C, no			DIN 43535 A	
6.4		Battery voltage, nominal capacity K_5		V/Ah	24/400	
6.5		Battery weight		kg	372	
Other	8.1	Type of drive control			inverter MOSFET	
	8.2	Operating pressure for attachments		bar	140	
	8.3	Oil volume for attachments		l/min	34,1	
	8.4	Sound level at the driver's ear according to EN 12 053		dB(A)	62,4	

Mast dimensions and rated capacities

Model			V							FW					FSW					
7FBEST10	Lift height	h_{23}	3010	3310	3510	3710	4010	4510	5010	3010	3310	3510	3710	4010	4320	4710	5010	5510	6010	6510
	Lift	h_3	2970	3270	3470	3670	3970	4470	4970	2970	3270	3470	3670	3970	4280	4670	4970	5470	5970	6470
	Height, mast lowered	h_1	1990	2140	2240	2340	2490	2740	3090	1990	2140	2240	2340	2490	1960	2090	2190	2390	2540	2740
	Height, mast extended ¹⁾	h_4	3515	3815	4015	4215	4515	5015	5535	3515	3815	4015	4215	4515	4825	5215	5515	6015	6515	7015
	Height, mast extended ²⁾	h_4	4090	4390	4590	4790	5090	5590	6090	4090	4390	4590	4790	5090	5400	5790	6090	6590	7090	7590
	Free lift, without load backrest	h_2	80	80	80	80	80	80	80	1445	1595	1695	1795	1945	1415	1545	1645	1845	1995	2195
	Free lift, with load backrest	h_2	80	80	80	80	80	80	80	870	1020	1120	1220	1370	840	970	1070	1270	1420	1620

1) Without load backrest.

2) With load backrest; height of standard load backrest is 1120 mm.

Pneumatic shaped cushion/cushion tyre			V							FW					FSW					
7FBEST10	Tilt range, forward	deg	5(6)	5(6)	5(6)	5(6)	5(6)	5(6)	5(6)	5(6)	5(6)	5(6)	5(6)	5(6)	5(6)	5(6)	5(6)	5(6)	5(6)	5(6)
	Tilt range, backward	deg	6(5)	6(5)	6(5)	6(5)	6(5)	6(5)	6(5)	6(5)	6(5)	6(5)	6(5)	6(5)	6(5)	6(5)	6(5)	6(5)	6(5)	6(5)
	Load capacity at 500 mm LC	kg	1000	1000	1000	1000	1000	1000	940	1000	1000	1000	1000	1000	1000	970	920	840	730	650

Pneumatic tyre			V							FW					FSW					
7FBEST10	Tilt range, forward	deg	5(6)	5(6)	5(6)	5(6)	5(6)	5(6)	5(6)	5(6)	5(6)	5(6)	5(6)	5(6)	5(6)	5(6)	5(6)	5(6)	5(6)	5(6)
	Tilt range, backward	deg	6(5)	6(5)	6(5)	6(5)	6(5)	6(5)	6(5)	6(5)	6(5)	6(5)	6(5)	6(5)	6(5)	6(5)	6(5)	6(5)	6(5)	6(5)
	Load capacity at 500 mm LC	kg	1000	1000	1000	1000	980	930	900	1000	1000	1000	1000	980	950	900	830	750	550	400

Data in () are for when "Cabin Series" is selected (minimum front windshield).

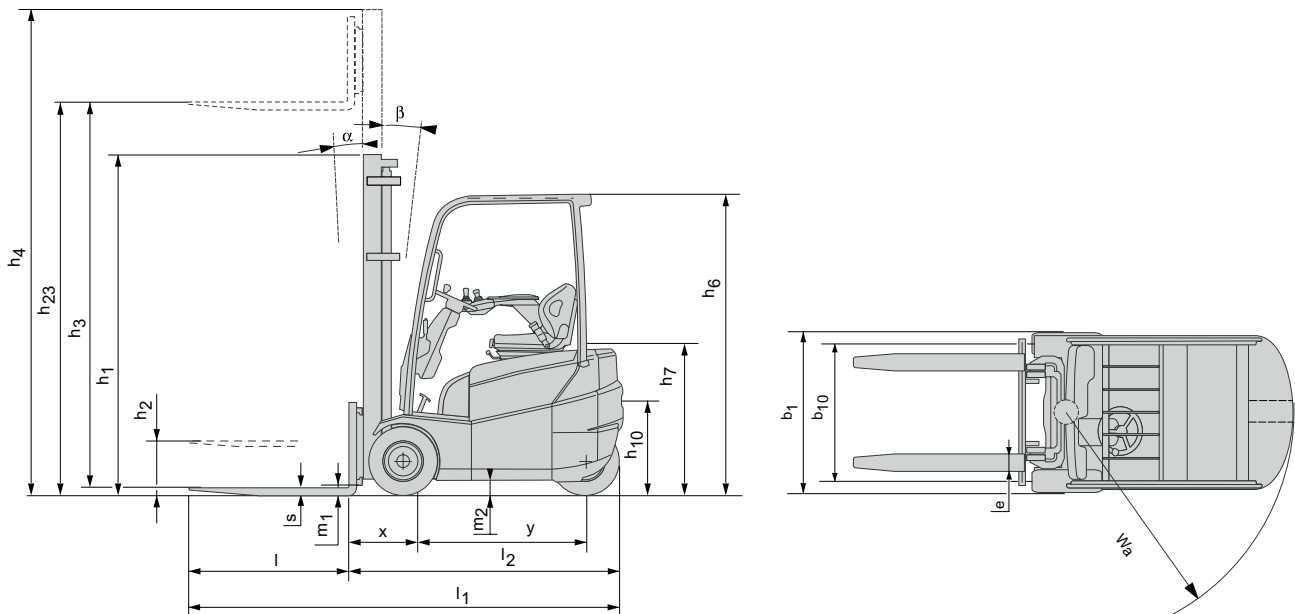

Underclearance		
Mast, load	mm	55
Front axle, load	mm	90
Steer axle, no load	mm	85
Center of wheelbase, load	mm	80
Counterweight, no load	mm	60

Underclearance is the same for standard and battery side-out model.